

Note d'application

Application of GC-Triple Quadrupole MS/MS for Multi-Residue Analysis of Pesticides in Complex Matrices

David Douce, Peter Hancock, Stephanie Dudd, Hans G.J. Mol

Waters Corporation, TNO, Zeist, The Netherlands

Abstract

In this application note, gas chromatography (GC) with tandem quadrupole mass spectrometric detection (GC-MS/MS) was used to achieve the required selectivity.

Benefits

- The Waters Micromass Quattro micro GC can be used in routine analysis at 10 ms dwell times
 - Good sensitivity for the majority of pesticide residues
-

Introduction

There are over 800 registered pesticides in use worldwide, and an ever-increasing requirement to monitor the levels of these compounds in foodstuffs. Under EU legislation, maximum residue limits (MRLs) are specified for

pesticides considered a potential health risk; guidelines for developing analytical methods must be followed.

The analytical challenge is to maximize the number of pesticides, minimize the variety of methods, keep run times short and achieve limits of detection (LODs) at or below the reporting level. Multi-residue methods are efficient for analysis of pesticide residues. For methods with a very wide scope, generic sample preparation procedures are employed. Inherent to this approach is that clean up of extracts is only possible to a limited extent. When applying such methods to complex matrices like baby food, herbs, spices and tobacco, enhanced selectivity in detection is required to make up for the low selectivity in sample preparation.

Whereas single quadrupole and ion trap MS instruments are suitable for simple matrices where LODs of >0.01 mg/kg are required, these detection systems provide insufficient selectivity for complex food matrices, such as baby food, garlic, ginger, herbs, and spices. In this work, gas chromatography (GC) with tandem quadrupole mass spectrometric detection (GC-MS/MS) was used to achieve the required selectivity.

Requirements of the analytical method:

- A simple and generic, rapid extraction method, allowing recovery of multiple classes of pesticides (OP, OC, pyrethroids, etc.)
- Analysis of 100 or more pesticides in 1 run
- LODs at or lower than the reporting level
- Need for targeting multiple compounds in a variety of produce/matrices
- Efficient use of time/instrumentation/personnel (Multiresidue methods)
- Selective MS detection method (required to compensate for less selective sample prep)
- Adequate sensitivity to keep amount of (dirty) matrix introduced into the GC system as low as possible



Figure 1. Waters Micromass Quattro micro GC.

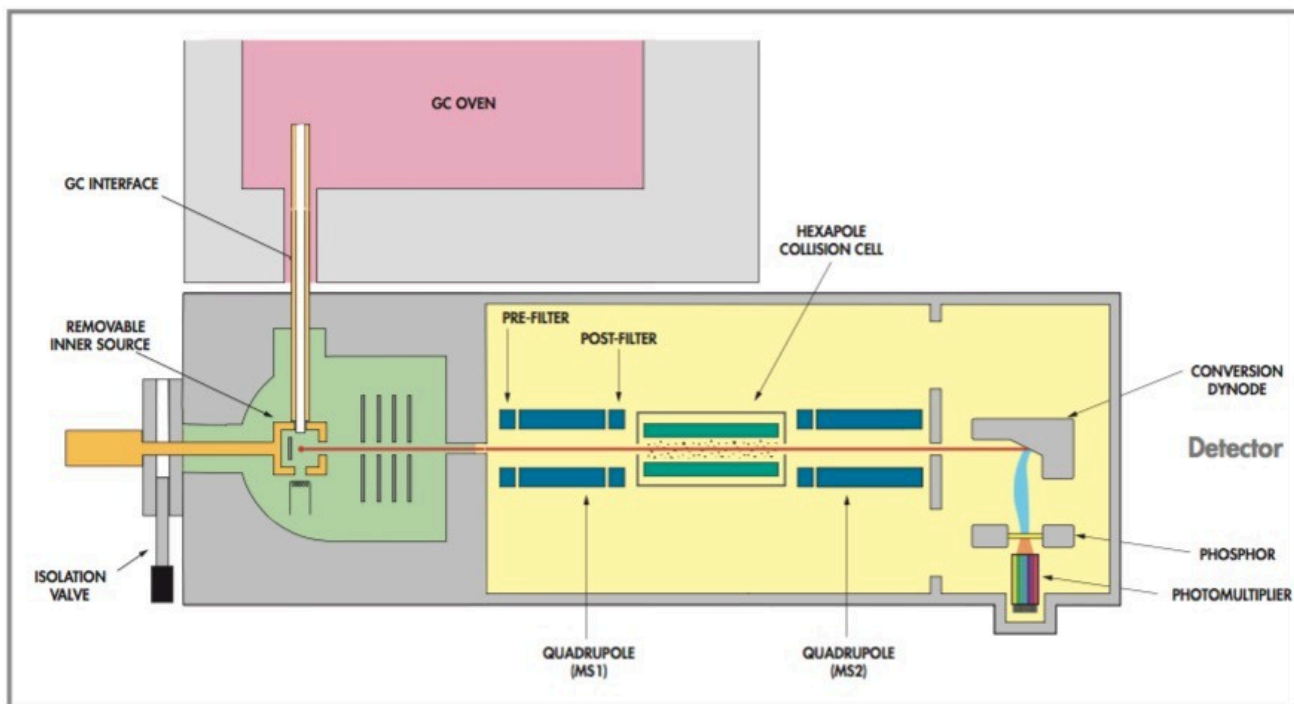

Figure 2. Waters Micromass Quattro micro GC instrument schematic.

Experimental

Instrumentation

GC-MS/MS:	Waters Micromass Quattro micro GC
GC:	Agilent 6890 with PTV injector
Injection:	2 μ L, solvent vent injection
Column:	30 m x 0.25 mm ID, 0.25 μ m DB5MS

Carrier gas:	Helium, 1.0 mL/min (constant flow)
Temperature program:	50 °C (2 min) ramp 1 @25 °C/min – 150 °C ramp 2 @5 °C /min – 280 °C (4 mins) Total run time 36 mins
MS/MS:	Waters Micromass Quattro micro GC operated in Multiple Reaction Monitoring (MRM) mode
Ionization:	EI positive ion
Q2 pressure:	2.5×10^{-3} mbar (argon)
Collision energy:	see Table 1

Pesticide	Retention time	Precursor ion	Product ion	Collision energy (V)	Corr.coef. [r ²]	LOD (pg)	Pesticide	Retention time	Precursor ion	Product ion	Collision energy (V)	Corr.coef. [r ²]	LOD (pg)
dichlorvos	7,08	185	93	12	0,998	3	dieldrin	21,04	237	165	20	0,976	5
mevinphosacid	8,68	192	127	10	0,994	1	TDE, o,p'	21,15	235	165	15	0,973	3
mevinphostrans	8,72	192	127	10	0,995	1	cinetrin-I	21,47	123	81	7	0,997	4
ethoprophos	11,60	158	114	5	0,999	4	endrin	21,78	263	193	25	0,994	17
chlorpropham	11,93	213	171	5	0,998	4	nitrofen	21,81	283	253	10	0,998	30
cadusafos	12,40	159	131	5	0,998	5	endosulfan-beta	22,20	237	143	25	0,983	22
phorate	12,51	260	75	5	0,906	26	fensulfathion	22,28	292	109	10	0,993	9
HCH-alfa	12,65	181	145	10	0,997	8	TDE, p,p'	22,45	235	165	15	0,999	1
hexachlorobenzene	12,73	284	249	15	0,999	2	DDT, o,p'	22,54	235	165	15	0,981	4
dimethoate	13,05	229	87	5	0,996	12	ethion	22,55	231	129	20	0,993	2
carbafuran	13,26	164	149	8	0,998	3	jasmolini	22,80	164	109	8	0,996	17
HCH-beta	13,48	181	145	10	0,999	4	triazophos	23,12	257	162	5	0,994	11
dimethipin	13,48	118	58	7	0,997	25	carbaphenothion	23,47	342	157	10	0,991	8
quinoxizene	13,51	295	237	15	0,997	11	endosulfan-sulphate	23,60	387	241	15	0,986	44
lindane	13,70	181	145	10	0,997	5	DDT,p,p'	23,83	235	165	20	0,971	4
diazinon	14,12	179	137	15	0,995	15	propargite	24,51	135	107	12	0,998	9
chlorothalonil	14,22	266	133	25	0,996	5	piperonylbutoxide	24,79	176	131	10	0,993	4
pentachloroaniline	15,14	165	194	20	0,995	5	pyrethrin-I	25,20	133	105	8	0,999	12
phosphamidon	15,43	264	127	10	0,995	8	phosmet	25,49	160	77	20	0,990	3
chlorpyrifos-methyl	15,66	286	93	18	0,995	4	bramopropylate	25,71	341	183	15	0,996	2
vinclozolin	15,82	212	145	20	0,998	6	fenpropathrin	26,09	181	152	20	0,996	4
parathion-methyl	15,89	263	127	8	0,990	6	tetracifon	26,60	229	201	12	0,999	4
atachlar	15,93	188	160	8	0,994	3	phosalone	26,86	182	111	10	0,994	5
carbaryl	16,10	144	115	20	0,997	2	phenothrin	26,86	183	153	12	0,993	11
heptachlor	16,12	272	237	10	0,994	2	azinphos-methyl	26,95	160	132	5	0,987	11
pirimiphos-methyl	16,73	290	125	15	0,999	3	cinetrin-II	27,05	169	107	5	0,997	90
MPCPS	16,84	296	263	12	0,998	2	cyhalothrin-lambda	27,73	197	141	10	0,996	3
malathion	17,16	173	99	10	0,997	3	azinphos-ethyl	28,17	160	132	5	0,992	3
chlorpyrifos	17,34	197	169	20	0,994	8	acrinathrin	28,17	181	152	18	0,994	6
aldrin	17,36	263	193	22	0,991	7	jasmolini	28,25	163	121	6	0,995	23
fenthion	17,50	278	109	12	0,929	10	permethrin-cis	29,23	183	153	12	0,996	4
parathion	17,64	291	109	10	0,986	21	permethrin-trans	29,50	183	153	12	0,997	3
fenproprymor	17,66	303	128	5	0,985	6	prochloraz	29,51	180	152	20	0,989	47
triadimelfon	17,75	208	181	6	0,996	6	cyfluthrin I	30,33	163	127	5	0,997	2
chloridone, oxy	18,76	185	121	10	0,998	5	cyfluthrin II	30,55	163	127	5	0,996	1
fipronil	18,76	367	213	25	0,996	5	cyfluthrin III	30,64	163	127	5	0,994	3
heptachlor-epoxide	18,90	353	257	15	0,994	11	cyfluthrin IV	30,75	163	127	5	0,993	5
chlorfenvinphos	18,94	325	269	10	0,991	8	cypermethrin I	30,97	163	127	5	0,993	2
phenothate	19,10	274	121	7	0,995	5	cypermethrin II	31,18	163	127	5	0,996	3
quinalphos	19,13	146	118	7	0,996	2	cypermethrin III	31,28	163	127	5	0,995	2
triadimelfon	19,27	168	70	5	0,990	31	flucytrinate I	31,32	199	157	5	0,994	1
methidathion	19,59	145	85	5	0,996	1	cypermethrin IV	31,38	163	127	5	0,997	2
chloridone-alfa	19,61	373	266	15	0,995	5	etofenprox	31,59	163	135	10	0,997	1
tetrachlorvinphos	19,87	329	109	18	0,994	3	flucytrinate II	31,73	199	157	5	0,997	1
endosulfan-alfa	20,06	237	143	25	0,998	16	fenvalerate I	32,71	167	125	8	0,997	2
chloridone-gamma	20,07	373	266	15	0,995	24	fluvalinate, tau-	33,03	250	200	20	0,998	17
prothiofos	20,66	267	239	5	0,989	6	fenvalerate II	33,18	167	125	8	0,997	4
profenofos	20,85	337	267	8	0,992	5	fluvalinate, tau-	33,22	250	200	20	0,994	4
DDE, p,p'	20,95	246	176	22	0,997	1	deltamethrin	34,48	181	152	18	0,998	6

Table 1. Precursor and products ions, linearity, and LODs.

Sample Preparation

Sample amount:	2.5–25 g
Extraction:	50 mL ethyl acetate
Clean up:	PSA and GCB (dispersive)
Final extract:	0.05–0.5 g/mL

Method development

In order to maximize the response of the instrument for each residue the choice of precursor ion, product ion, and collision energy were optimized. Initially, the pesticide mixture was analysed in full scan mode (Figure 3).

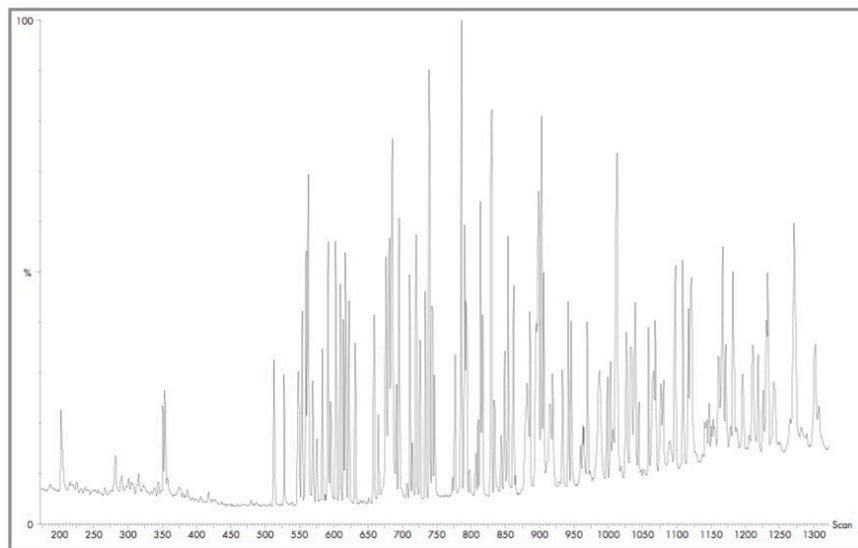

Figure 3. GC-MS full scan chromatogram (solvent standard of 100 pesticides).

The precursor ion was selected from the full scan spectra based on its relative abundance, e.g. Endosulfan-beta (MW = 404; Figure 4).

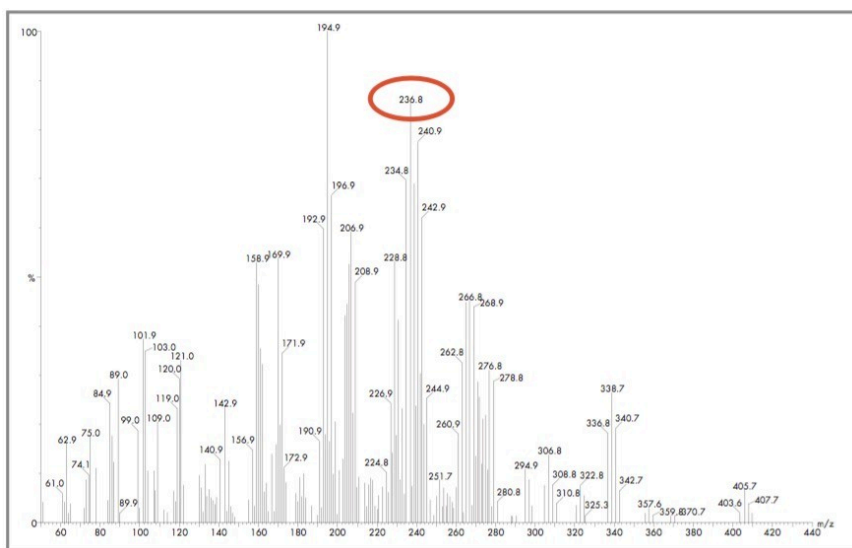

Figure 4. Full scan background subtracted spectrum of Endosulfan-beta.

The collision energy for the product ion was optimised using a range of collision energies between 5–30 eV (Figure 5).

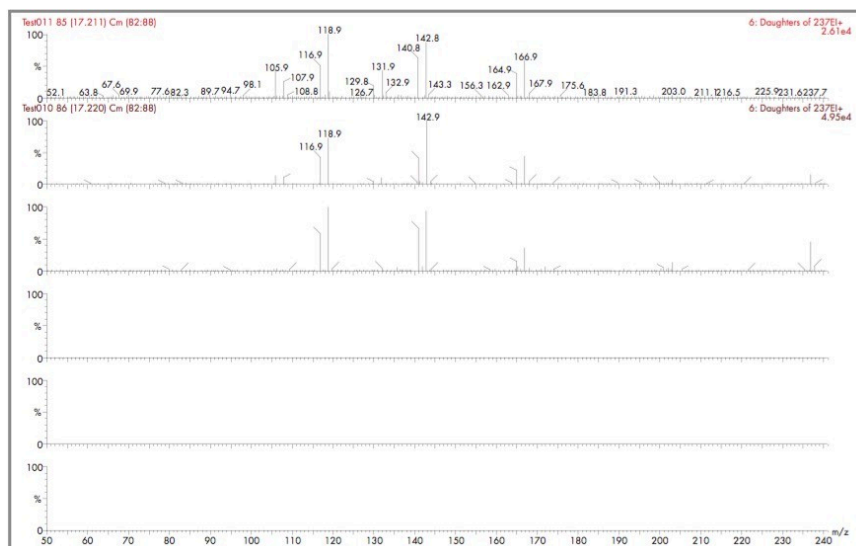

Figure 5. MS/MS optimization.

Method Performance

For the majority of pesticides, LoDs were below 10 pg on column (based on S/N >3:1; Table 1). The ability to quantify closely eluting peaks is a prerequisite of multiresidue methods. Therefore, the dwell time allocated for each transition must be sufficient to ensure that at least 10 data points are acquired for accurate quantification. To assess the effect of short dwell times on data quality a standard solution of hexachlorobenzene was acquired using a range of dwell times.

Figure 6 illustrates that the signal intensity is unaffected by the shorter dwell time. With a 10 ms dwell time, the S/N measured is sufficient for quantification of the target compounds.

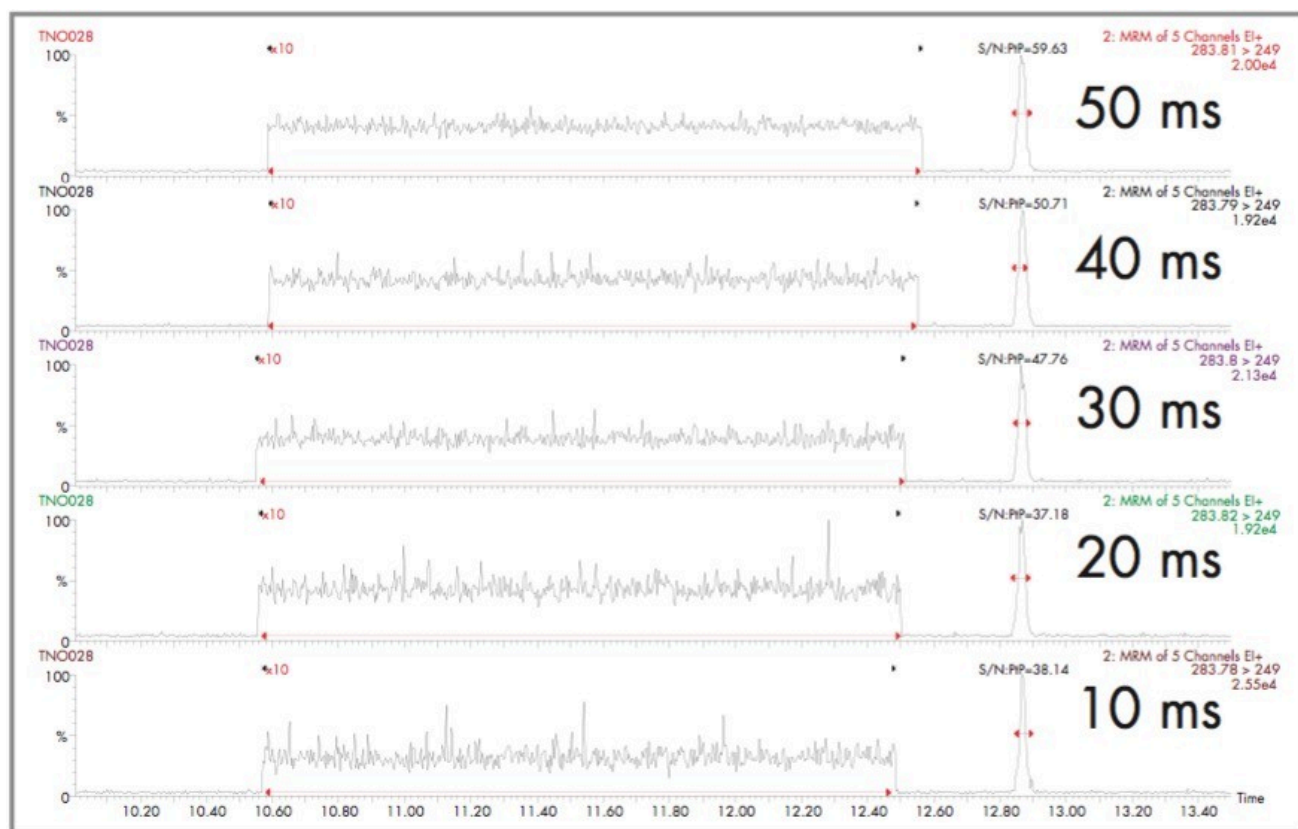

Figure 6. 2 μ L standard solution of hexachlorobenzene (10 μ g/ μ L) acquired using a range of dwell times, from 10–50 ms.

To assess instrument robustness, hexachlorobenzene (20 pg on-column) was analyzed repeatedly (n = 10) at a range of different dwell times, from 10–50 ms. The %RSD shown in Table 2 illustrates the repeatability of injection was less than 5%.

Hexachlorobenzene (20 pg)	
Dwell (ms)	% RSD (n = 10)
10	3.0
20	4.4
30	3.9
40	2.5
50	2.8

Table 2. Effect of dwell time on repeatability.

For 100 pesticide residues, the optimum experimental setup utilized 84 MRM transitions in 14 MRM function windows, with 4 to 8 transitions in each window (Figure 7). With this setup, at any point in time, the maximum number of transitions acquired was 15.

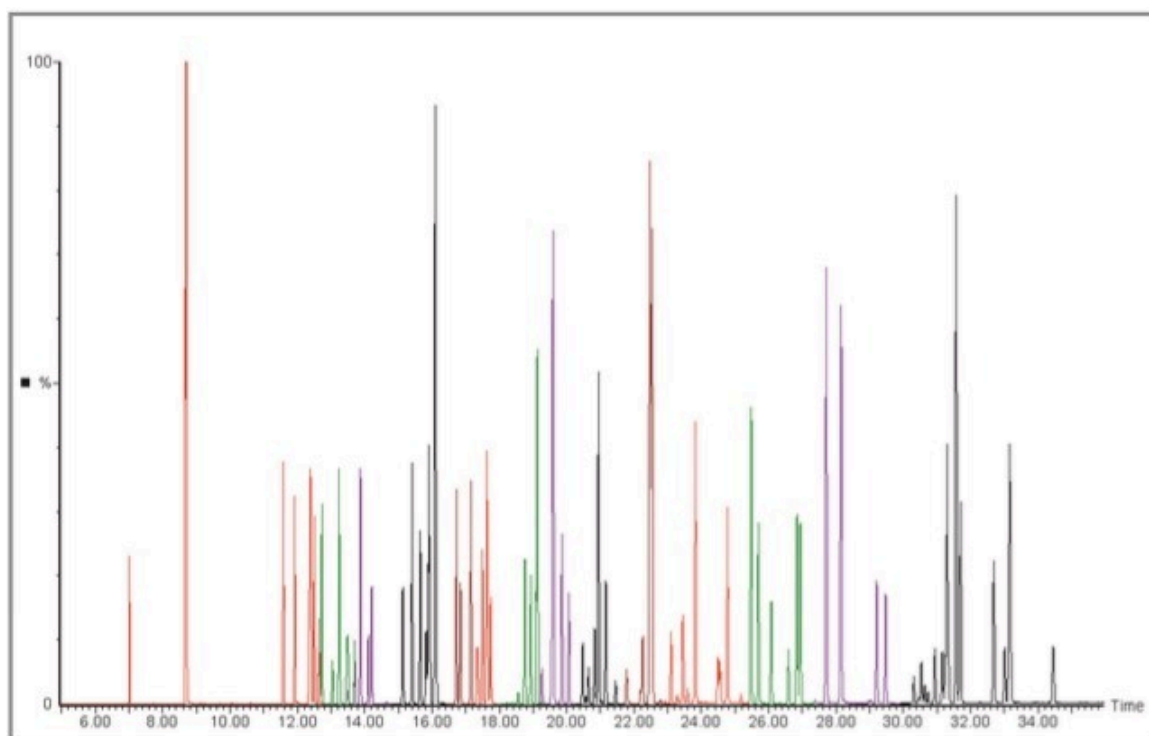

Figure 7. TIC of 100 pesticides in MRM mode. Each color corresponds to a different function window.

The linearity of the system is illustrated in Figure 8.

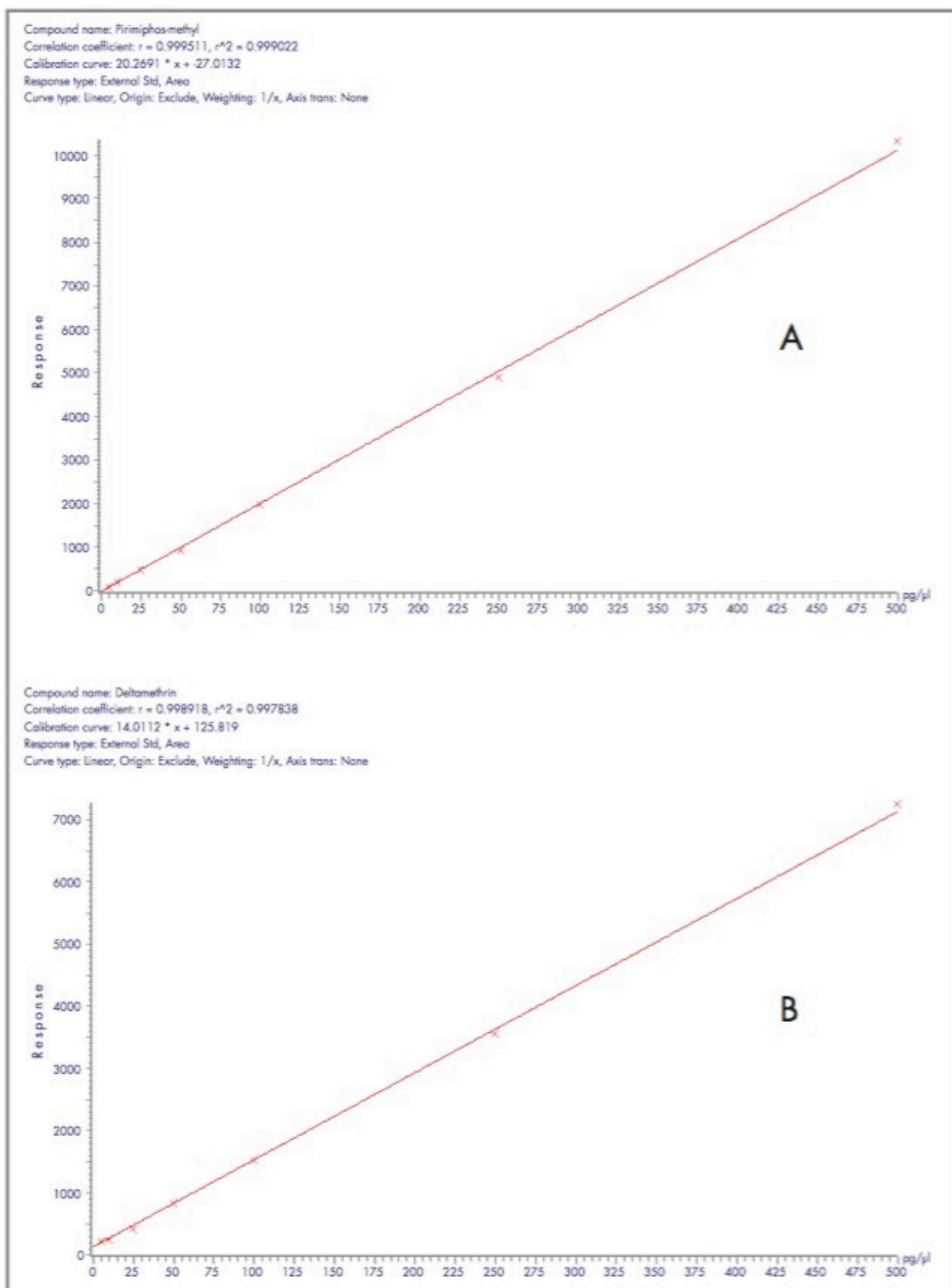

Figure 8. Calibration curves for A) Pirimiphos-methyl ($T_r = 16.73$ mins) and B) Deltamethrin ($T_r = 34.48$ mins)

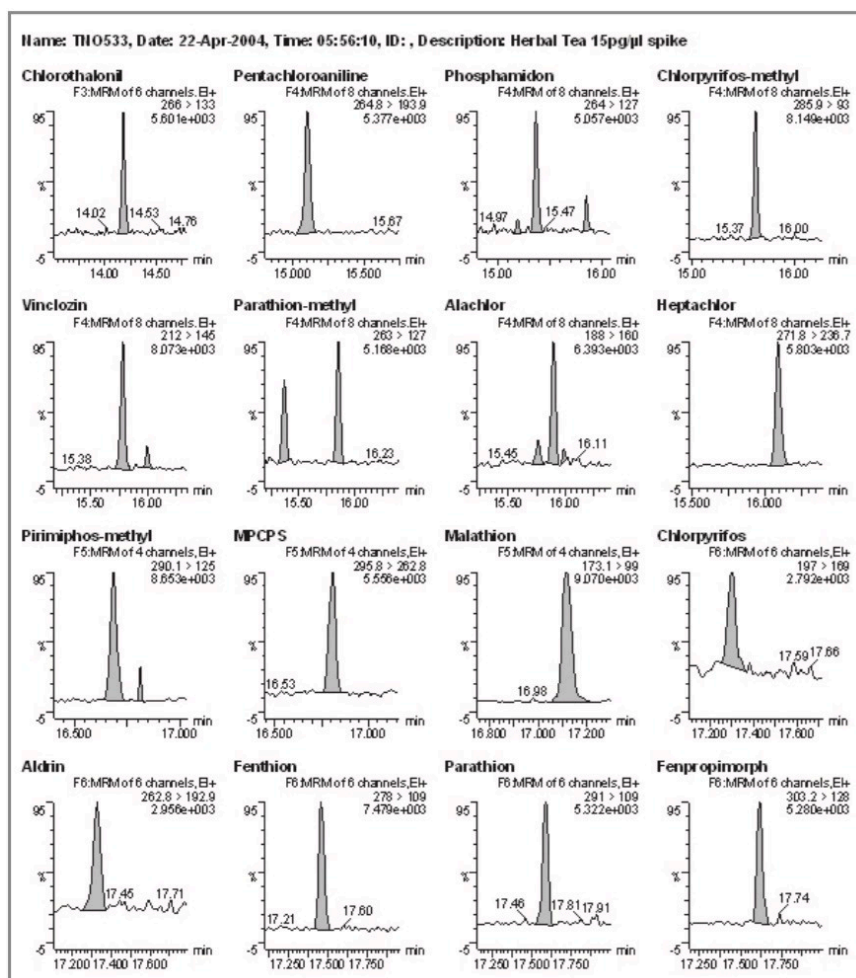

Figure 10. GC-MS/MS of selected pesticides in herbal tea (0.3 mg/kg dry).

In all cases (Table 3), a high percentage of the spiked pesticides were detected and measured, despite the highly complex matrices, generic sample preparation and limited clean up employed.

Product	Pesticide fortification	Compounds spiked	Compounds found	% found
Baby food	0.01 mg/kg	93	81	87
Baby food	0.05 mg/kg	93	92	99
Herbal tea	0.03 mg/kg	93	88	95
Herbal mix	0.03 mg/kg	93	87	94
Curry	0.15 mg/kg	93	90	97
Massala	0.15 mg/kg	93	87	94
Tobacco	0.15 mg/kg	93	87	94
Ginko	0.02–4.0 mg/kg	52	44	85
Cannabis	0.02–4.0 mg/kg	52	41	79

Table 3. Summary of performance in terms of selectivity.

Conclusion

- A multiresidue method has been developed for the surveillance monitoring of 100 pesticide residues in a range of food matrices
- Sufficient selectivity has been achieved to allow generic sample clean up, even for very complex food matrices
- The Waters Micromass Quattro micro GC can be used in routine analysis at 10 ms dwell times. Subsequent expansion of this method to include an increased number of MRM transitions would be possible without a loss in sensitivity
- The system provided good sensitivity (1–10 pg on column) for the majority of pesticide residues, allowing the amount of matrix introduced into the GC system to be minimized

720000987, October 2004

© 2022 Waters Corporation. All Rights Reserved.